

DDTA (R1 = R2 SERIES) E

PNP PRE-BIASED SMALL SIGNAL SOT-523 SURFACE MOUNT TRANSISTOR

NEW PRODUCT

Features

- Epitaxial Planar Die Construction
- Complementary NPN Types Available (DDTC)
- Built-In Biasing Resistors, R1 = R2
- **Lead Free/RoHS Compliant (Note 2)**

Mechanical Data

- Case: SOT-523
- Case Material: Molded Plastic. UL Flammability Classification Rating 94V-0
- Moisture Sensitivity: Level 1 per J-STD-020C
- Terminals: Finish - Solderable per MIL-STD-202, Method 208
- Lead Free Plating (Matte Tin Finish annealed over Alloy 42 leadframe).
- Terminal Connections: See Diagram
- Marking: Date Code and Marking Code (See Diagrams & Page 2)
- Weight: 0.002 grams (approx.)
- Ordering Information (See Page 2)

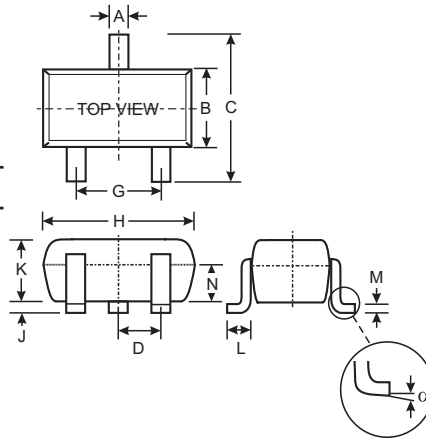

SOT-523			
Dim	Min	Max	Typ
A	0.15	0.30	0.22
B	0.75	0.85	0.80
C	1.45	1.75	1.60
D	—	—	0.50
G	0.90	1.10	1.00
H	1.50	1.70	1.60
J	0.00	0.10	0.05
K	0.60	0.80	0.75
L	0.10	0.30	0.22
M	0.10	0.20	0.12
N	0.45	0.65	0.50
α	0°	8°	—

All Dimensions in mm

P/N	R1, R2 (NOM)	MARKING
DDTA123EE	2.2K Ω	P04
DDTA143EE	4.7K Ω	P08
DDTA114EE	10K Ω	P13
DDTA124EE	22K Ω	P17
DDTA144EE	47K Ω	P20
DDTA115EE	100K Ω	P24

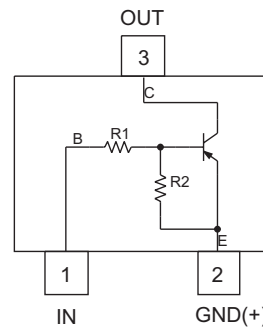

Schematic and Pin Configuration

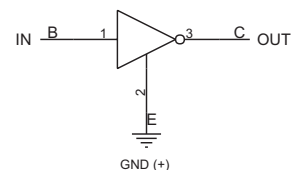

Equivalent Inverter Circuit

Maximum Ratings @ T_A = 25°C unless otherwise specified

Characteristic	Symbol	Value	Unit
Supply Voltage, (2) to (3)	V _{CC}	-50	V
Input Voltage, (1) to (2)	V _{IN}	DDTA123EE: +10 to -12 DDTA143EE: +10 to -30 DDTA114EE: +10 to -40 DDTA124EE: +10 to -40 DDTA144EE: +10 to -40 DDTA115EE: +10 to -40	V
Output Current	I _O	DDTA123EE: -100 DDTA143EE: -100 DDTA114EE: -50 DDTA124EE: -30 DDTA144EE: -30 DDTA115EE: -20	mA
Power Dissipation	P _d	150	mW
Thermal Resistance, Junction to Ambient Air (Note 1)	R _{θJA}	833	°C/W
Operating and Storage and Temperature Range	T _j , T _{STG}	-55 to +150	°C

- Note:
1. Mounted on FR4 PC Board with recommended pad layout at <http://www.diodes.com/datasheets/ap02001.pdf>.
 2. No purposefully added lead.

Electrical Characteristics @ T_A = 25°C unless otherwise specified

Characteristic		Symbol	Min	Typ	Max	Unit	Test Condition
Input Voltage		V _{I(off)}	-0.5	-1.1	—	V	V _{CC} = 5V, I _O = 100μA
		V _{I(on)}	—	-1.9	-3		V _O = 0.3V, I _O = 20mA, DDTA123EE V _O = 0.3V, I _O = 20mA, DDTA143EE V _O = 0.3V, I _O = 10mA, DDTA114EE V _O = 0.3V, I _O = 5mA, DDTA124EE V _O = 0.3V, I _O = 2mA, DDTA144EE V _O = 0.3V, I _O = 1mA, DDTA115EE
Output Voltage		V _{O(on)}	—	-0.1	-0.3	V	I _O /I _I = 10mA/0.5mA, DDTA123EE I _O /I _I = 10mA/0.5mA, DDTA143EE I _O /I _I = 10mA/0.5mA, DDTA114EE I _O /I _I = 10mA/0.5mA, DDTA124EE I _O /I _I = 10mA/0.5mA, DDTA144EE I _O /I _I = 5mA/0.25mA, DDTA115EE
Input Current	DDTA123EE DDTA143EE DDTA114EE DDTA124EE DDTA144EE DDTA115EE	I _I	—	—	-3.8 -1.8 -0.88 -0.36 -0.18 -0.15	mA	V _I = -5V
Output Current		I _{O(off)}	—	—	0.5	μA	V _{CC} = -50V, V _I = 0V
DC Current Gain	DDTA123EE DDTA143EE DDTA114EE DDTA124EE DDTA144EE DDTA115EE	G _I	-20 -20 -30 -56 -68 -82	—	—	—	V _O = -5V, I _O = -20mA V _O = -5V, I _O = -10mA V _O = -5V, I _O = -5mA V _O = -5V, I _O = -5mA V _O = -5V, I _O = -5mA V _O = -5V, I _O = -5mA
Input Resistor (R ₁) Tolerance		ΔR ₁	-30	—	+30	%	—
Resistance Ratio		R ₂ /R ₁	0.8	1	1.2	—	—
Gain-Bandwidth Product*		f _T	—	250	—	MHz	V _{CE} = -10V, I _E = 5mA, f = 100MHz

* Transistor - For Reference Only

Ordering Information (Note 3)

Device	Packaging	Shipping
DDTA123EE-7-F	SOT-523	3000/Tape & Reel
DDTA143EE-7-F	SOT-523	3000/Tape & Reel
DDTA114EE-7-F	SOT-523	3000/Tape & Reel
DDTA124EE-7-F	SOT-523	3000/Tape & Reel
DDTA144EE-7-F	SOT-523	3000/Tape & Reel
DDTA115EE-7-F	SOT-523	3000/Tape & Reel

Notes: 3. For Packaging Details, go to our website at <http://www.diodes.com/datasheets/ap02007.pdf>.

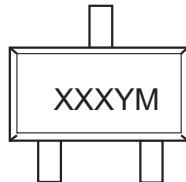
Marking Information

XXX = Product Type Marking Code (See Page 1, e.g. P04 = DDTA123EE)
 YM = Date Code Marking
 Y = Year ex: T = 2006
 M = Month ex: 9 = September

Date Code Key

Year	2005	2006	2007	2008	2009	2010
Code	S	T	U	V	W	X

Month	Jan	Feb	Mar	Apr	May	Jun	Jul	Aug	Sep	Oct	Nov	Dec
Code	1	2	3	4	5	6	7	8	9	O	N	D

TYPICAL CURVES - DDTA143E

NEW PRODUCT

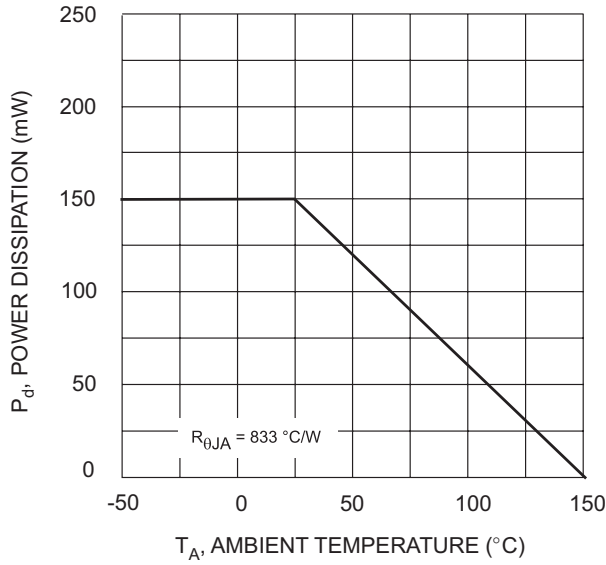

Fig. 1 Derating Curve

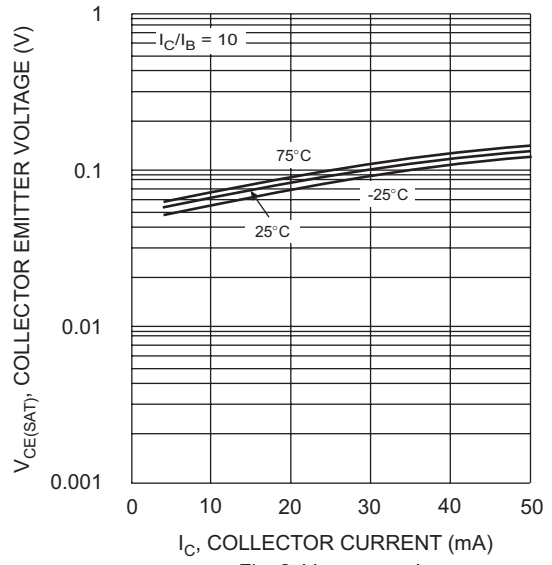

Fig. 2 $V_{CE(SAT)}$ vs. I_C

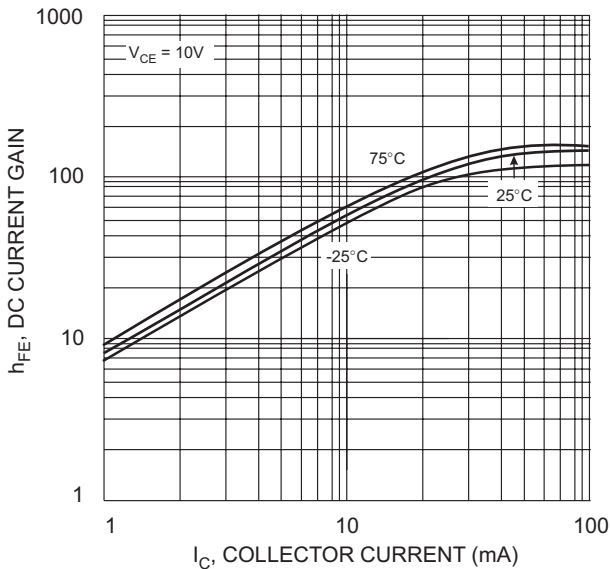

Fig. 3 DC Current Gain

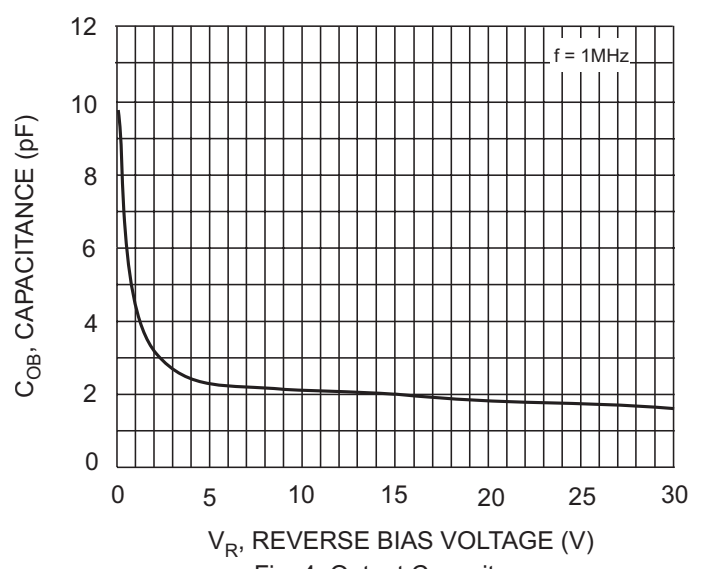

Fig. 4 Output Capacitance

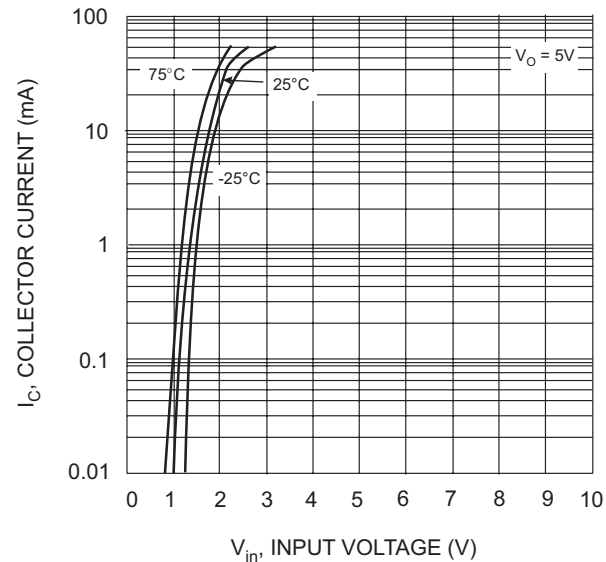

Fig. 5 Collector Current Vs. Input Voltage

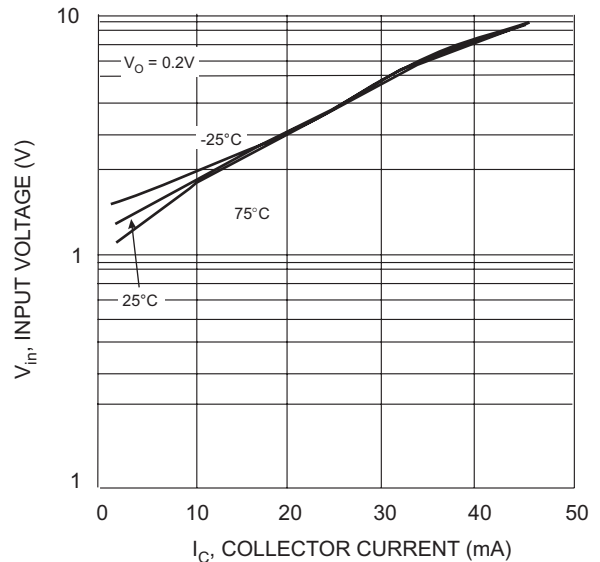

Fig. 6 Input Voltage vs. Collector Current

IMPORTANT NOTICE

Diodes Incorporated and its subsidiaries reserve the right to make modifications, enhancements, improvements, corrections or other changes without further notice to any product herein. Diodes Incorporated does not assume any liability arising out of the application or use of any product described herein; neither does it convey any license under its patent rights, nor the rights of others. The user of products in such applications shall assume all risks of such use and will agree to hold Diodes Incorporated and all the companies whose products are represented on our website, harmless against all damages.

LIFE SUPPORT

Diodes Incorporated products are not authorized for use as critical components in life support devices or systems without the expressed written approval of the President of Diodes Incorporated.